

Quick Start Reference Guide

Refer to Product Safety Manual for Safety Statements
Complete Owner's Manual available online

CLEAN FILTER

This oven displays CLEAN FILTER at user defined intervals. When the message displays ACP recommends cleaning the air filter thoroughly.

Cleaning the air filter will not shut off the message. The message will stop displaying automatically after 24 hours. Depending on microwave use and environmental conditions, the filter may need to be cleaned more frequently. Once the frequency is determined, set the option for the appropriate time frame.

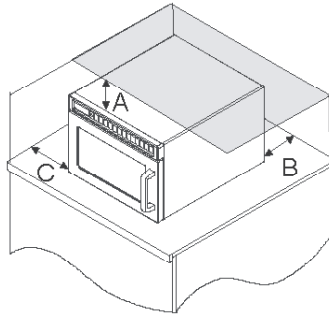

Oven Clearances

A—For North American (UL/CSA) models, allow at least 7" (17.8 cm) of clearance around top of oven. For International (50 Hz) models, allow at least 7" (17.8 cm) of clearance around top of oven. Proper air flow around oven cools electrical components. With restricted air flow, oven may not operate properly and life of electrical parts is reduced.
B—Allow at least 2 9/16" (6.5 cm) between air discharge on back of oven and back wall.
C—Allow at least 7" (17.8 cm) around sides of oven.

So...how do I use it?

1 Preprogrammed Pads

To cook food using preprogrammed cooking sequences.

1. Open oven door and place food in oven. Close door.
2. Press desired pad.
3. Oven begins to cook.
4. At end of cooking cycle oven beeps and shuts off.

x2 X2 Programming (some models)

To change the cooking factor:

1. Open oven door.
2. Press and hold pad 1 for approximately 5 seconds.
3. Press pad to be reprogrammed.
4. Press the X2 pad.
5. Press a numbered pad to change the cooking factor.
 - Cooking factor can be set from 10% to 100%.
 - Default is 80%.
 - Pad 5 would change the cooking factor to 50%.
6. Press START pad to save changes.

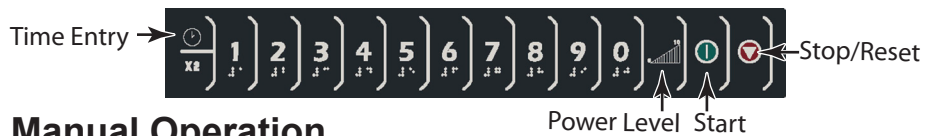

Manual Operation

To cook food using a specific entered time and power level.

1. Open oven door and place food in oven. Close door.
 2. Press TIME ENTRY pad and enter cooking time.
 3. Press POWER LEVEL pad to program level of microwave power if desired.
 - For a lower microwave power, press pads 1 (for 10%), through 9 (for 90%), or 0 for no microwave energy.
- NOTE:** Press POWER LEVEL pad once to return to 100% microwave power.
4. Press START pad.
 5. At end of cooking cycle oven beeps and shuts off.

Programming Items

1. Open oven door.
 2. Press and hold pad 1 for approximately 5 seconds.
 3. Press pad to be reprogrammed.
 4. Enter cooking time by using the number pads.
 5. Press POWER LEVEL pad to program level of microwave power if desired.
 - For a lower microwave power, press pads 1 (for 10%), through 9 (for 90%), or 0 for no microwave energy.
- NOTE:** Press POWER LEVEL pad once to return to 100% microwave power.
6. Press TIME ENTRY pad to add up to four additional cooking stages.
 - Total cooking time cannot exceed 60 minutes.
 - Enter cook time and power level as in steps 4 and 5.
 7. Press START pad to set new programming changes to the pad.

NOTE: To discard changes, press STOP/RESET pad or close oven door.

X2 Pad (some models)

1. Open oven door and place food in oven. Close door.
2. Press X2 pad.
3. Press desired preprogrammed pad or pad sequence.
4. Oven begins cooking. Displayed cooking time is the total of original cooking time and added X2 time.

The switching operation of this microwave oven can cause voltage fluctuations on the supply line. The operation of this oven under unfavorable voltage supply conditions can have adverse effects. This device is intended for the connection to a power supply system with a maximum permissible system impedance Z_{max} of **0.31 Ohms** at the interface point of the user's supply. The user has to ensure that this device is connected only to a power supply system which fulfills the requirement above. If necessary, the user can ask the public power supply company for the system impedance at the interface point.

Quick Start Reference Guide

Refer to Product Safety Manual for Safety Statements
Complete Owner's Manual available online

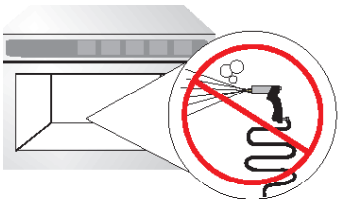

DO NOT power spray

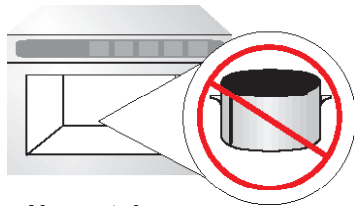



No metal pans

Can I change an option?

Options such as single or double pad programming, beep volume, and maximum cooking time can be changed to suit individual preferences.

To change options:

- Open oven door.
 - If door is closed or STOP/RESET  pad is pressed before programming is complete, changes are discarded and microwave exits programming mode.
- Press and hold pad 2 for approximately 5 seconds.
 - This begins options mode.
 - Microwave will beep and **OPTIONS:** displays.
- Press number pad that controls option to be changed.
 - See table below for options.
 - Current option will display.
- Press number pad again to change the option.
 - Each time pad is pressed, option will change.
 - Match code displayed with code for desired option.
- Press START  pad to save changes.
 - To change additional options, repeat steps 3 and 4.
 - Changes appear after door is closed or STOP/RESET  pad is pressed.

Numbered Pads	Display	Options (Factory Settings in Bold)
1 End of Cycle Beep	OP:10	3 second continuous beep.
	OP:11	Continuous beep until door is opened.
	OP:12	5 beeps bursts until door is opened.
2 Speaker Volume	OP:20	Eliminates beep.
	OP:21	Sets volume to low.
	OP:22	Sets volume to medium.
	OP:23	Sets volume to high.
3 Key Beep	OP:30	Prevents beep when pad is pressed.
	OP:31	Allows beep when pad is pressed.
4 Keyboard Enable Window	OP:40	15 seconds after oven door is opened, keyboard disabled.
	OP:41	30 seconds after oven door is opened, keyboard disabled.
	OP:42	1 minute after oven door is opened, keyboard disabled.
	OP:43	2 minutes after oven door is opened, keyboard disabled.
5 Add Time During Heating	OP:50	Prevents adding heating time while oven is heating.
	OP:51	Allows heating time to be changed while oven is heating when a memory pad is pressed.
6 Reset Door Open	OP:60	Allows oven to resume heating time countdown after door is opened during cycle.
	OP:61	Cancels heating time count down after door is opened during cycle.
7 Maximum Heating Time	OP:70	Allows 60 minutes of heating time.
	OP:71	Allows 10 minutes of heating time.
8 Manual Operation	OP:80	Allows use of preprogrammed pads only.
	OP:81	Allows use of manual time entry and preprogrammed pads.
9 Double Digit Operation	OP:90	Allows 10 (0-9) preprogrammed pads.
	OP:91	Allows 100 (00-99) preprogrammed pads.
0 Clean Filter Message	OP:00	Do not display message.
	OP:01	Display message for 24 hours every 7 days.
	OP:02	Display message for 24 hours every 30 days.
	OP:03	Display message for 24 hours every 90 days.