

Electronic Cooktop CE 490

Table of contents

Safety notes	4	Child lock	17
Before use	4	Activating the child lock	17
Safety when cooking	4	Deactivating the child lock	17
Damage to the cooktop	4		
Removable twist knob	4	Options menu	18
		Accessing the options menu	18
Operating for the first time	5	Settings of the options menu	19
Causes of damage	5	Cleaning and care	21
Pots and pans	5	Cleaning the glass ceramic	21
Food spills	5	Cleaning the stainless steel frame	21
Scratches on the glass ceramic	5	Cleaning the twist knob	21
Hard and pointed objects	5		
Removable twist knob	5	Useful hints	22
Features of your new cooktop	6	Maintenance	22
Cooking zones	6		
Control panel	7	Trouble shooting	23
Symbols	7		
Operating principle	8		
Main switch	8		
Touch keys	8		
Cooking zone combination	8		
Quick boil timer	8		
Twist pad with magnetic twist knob	8		
Storing the twist knob	8		
Operation	9		
Switching on and off	9		
Setting the cooking level	9		
Changing the cooking level	9		
Switching off a cooking zone	9		
Main switch with memory function	10		
Residual heat display	10		
Safety deactivation	10		
Tips on saving energy	11		
Cooking zone combination	12		
Combination of the dual size cooking zone	12		
Deactivating combination	12		
Settings table	13		
Timer	14		
Setting an automatic switch-off time	14		
Changing a time value	15		
Erasing a time value	15		
Timer	15		
Setting the timer	15		
Changing a time value	15		
Quick boil timer	16		
Switching on the quick boil timer	16		
Switching off the quick boil timer	16		



Safety notes

Before use

Read the instruction manual carefully before operating the cooktop. Only then will you be able to operate your cooktop safely and correctly. Keep the instruction and installation manual for future reference.

Do not connect the cooktop if it has been damaged.

This cooktop is intended only for domestic use. Only use the cooktop to prepare meals. Do not use the cooktop to heat up the room in which it is installed, the cooktop can overheat.

Do not let adults or children operate the appliance unsupervised:

- if they are mentally or physically unable to use the appliance safely and correctly
- if they don't have the knowledge and experience to use the appliance safely and correctly.

Never allow children to play with the appliance.

Do not operate this cooktop with an external timer or a separate telecontrol system.

Connecting cables from electrical appliances must not touch the hot cooking surface. This could cause damage to the cable insulation and the cooktop.

Caution, risk of fire! Never place inflammable items on the cooktop.

Caution, risk of fire! Do not store any combustible items, or substances that are sensitive to high temperatures, in drawers or cupboards under the cooktop (e.g. cleaning agents, aerosol cans).

Safety when cooking

Caution, risk of burns! Do not touch the hot cooking surface. Keep children away.

Caution, risk of burns! Cooking zones might still be hot even after being switched off. Only touch cooking zones after the residual heat display has gone off.

Caution, risk of fire! Overheated oil or fat can ignite very quickly. Never leave heating oil or fat unsupervised. Never pour water on burning oil. Cover pan with lid or plate, switch off the cooking zone. Leave the ovenware on the cooktop to cool down.

Always keep cooktop and pan base dry. Steam pressure can be generated from liquid between pan base and cooktop. The steam pressure could cause the pan to jump suddenly.

Damage to the cooktop

Caution! If there are fractures, breaks or cracks in the glass ceramic, there is a risk of electric shock. Switch off the corresponding household fuse. Call after-sales service.

Caution, risk of burns! Switch off the cooking zone if it heats up but the indicator is not working. Call after-sales service.

Caution, risk of fire! If the cooktop switches itself off and can no longer be operated, disconnect it from the electricity supply immediately. The cooktop could switch itself on later. Switch off the corresponding household fuse. Call after-sales service.

Incorrect repairs are dangerous. Repairs must be carried out by one of our experienced after-sales engineers.

Removable twist knob

Caution! For persons who wear electronic implants such as a pacemaker or insulin pump. Implants could be affected by magnetic fields. Do not carry the twist knob in the pockets of your clothing. Keep the twist knob at least 10 cm away from a pacemaker.

Operating for the first time

Remove the packaging from the appliance and dispose of it according to local regulations. Be careful to remove all accessories from the packaging. Keep packaging elements and plastic bags away from children.

Check the cooktop for transport damage after unpacking it. Do not connect the cooktop if it has been damaged.

The cooktop must be installed and connected by an authorised specialist. No warranty claims can be lodged for any damage resulting from incorrect connection. Observe the installation instructions.



This appliance is labelled in accordance with the European Directive 2002/96/EG concerning used electrical and electronic appliances (waste electrical and electronic equipment – WEEE). The guideline determines the framework for the return and recycling of used appliances as applicable.

Thoroughly clean the appliance before using it for the first time. This will eliminate any 'newness' smells and soiling.

Causes of damage

Pots and pans

Rough pan bases scratch the glass ceramic.

Avoid cooking on the cooktop with an empty pan, especially with enamel or aluminium pans. This could cause damage to the pan base and the glass ceramic.

Do not place hot pots or pans on the control panel, display area or the frame. This could cause damage.

Never heat food in aluminium foil or plastic containers. The material can melt and damage your cooktop.

Iridescent discoloration can be caused by the bases of some pans. These do not interfere with the operation of the glass ceramic cooktop. Remove the discoloration with glass ceramic cleaner.

Food spills

Milk, sugar and food with a high sugar content (e.g. jam) damage the glass ceramic surface. Remove food spills immediately with the glass scraper. **Caution!** The glass scraper has a sharp blade.

Scratches on the glass ceramic

Always keep the cooktop dry and clean. Salt, sugar and sand cause scratches on the glass ceramic. Do not use the cooktop as a work surface or storage space.

Hard and pointed objects

Damage can occur if hard or pointed objects fall on the cooktop. Do not store such objects above the cooktop.

Removable twist knob

Do not place the magnetic knob on the cooking zones. It could be damaged.

Metal parts attached to the underside of the magnetic knob could scratch the glass ceramic surface. Always keep the knob clean.

Features of your new cooktop

Cooking zones CE 490

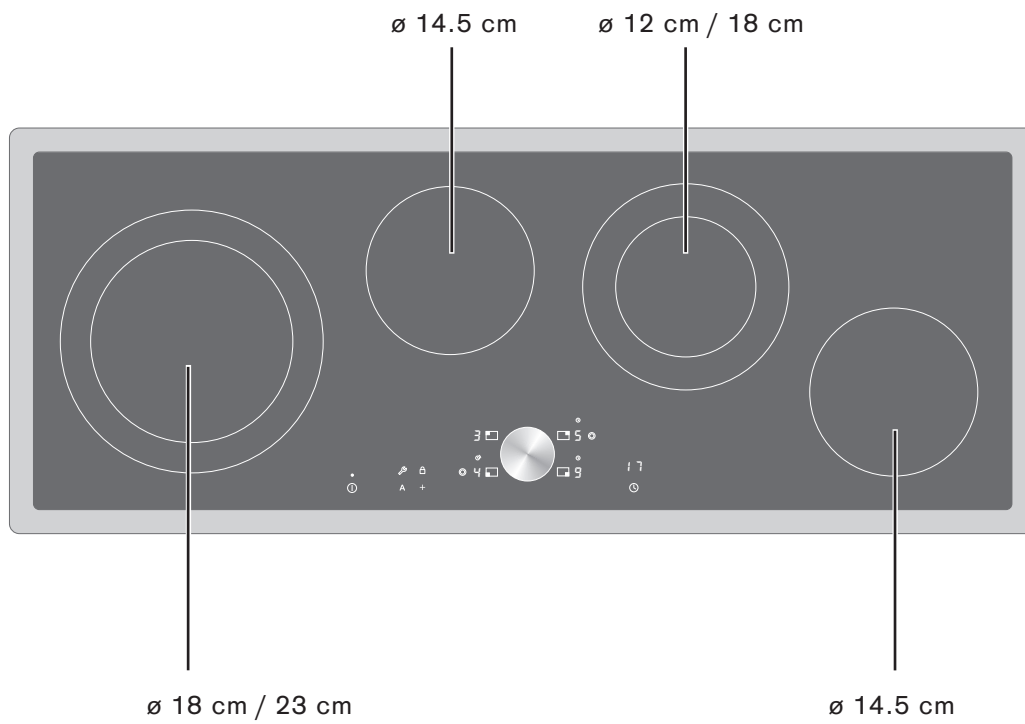

Control panel

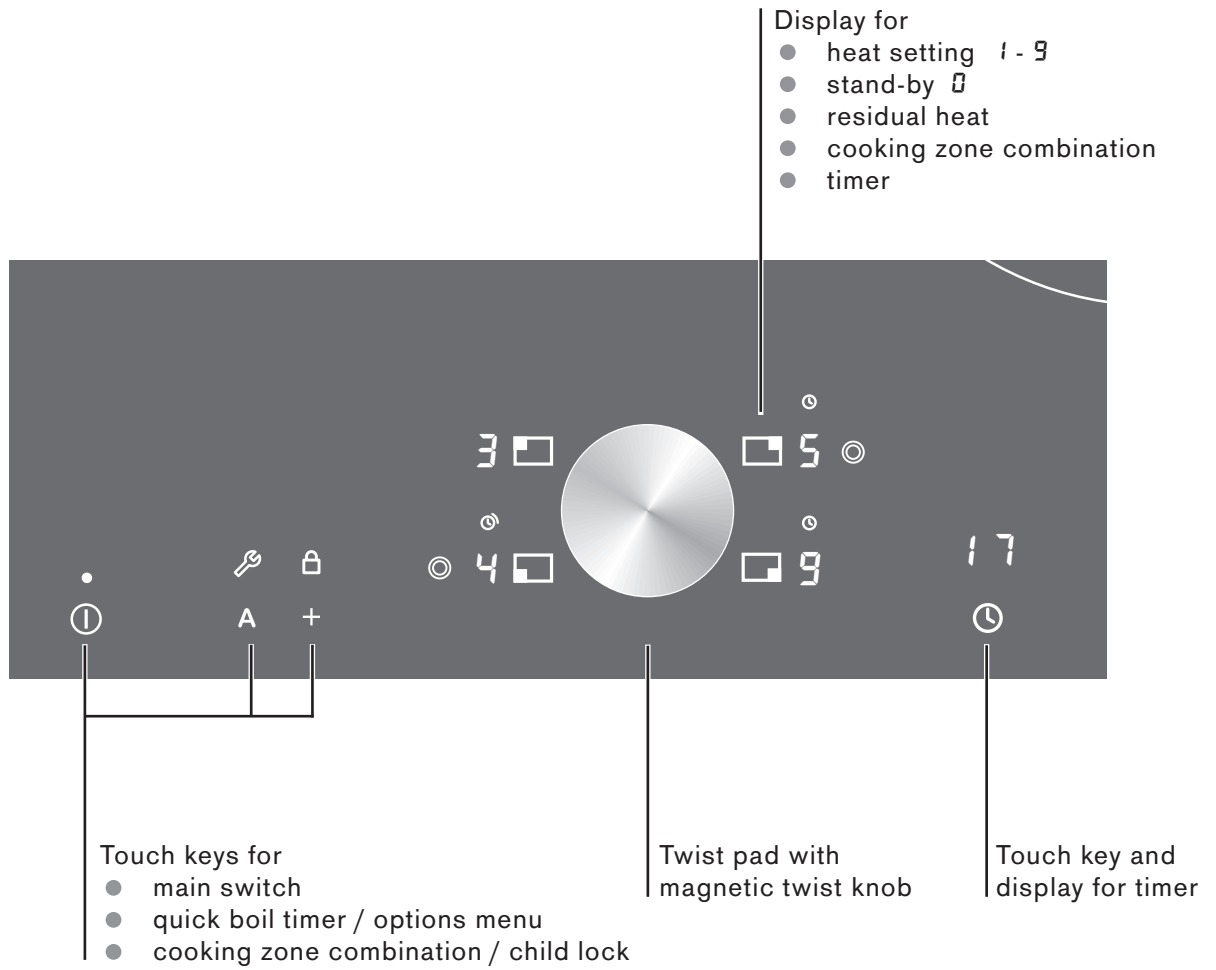



Symbols

- | | | | |
|----------------------------|---|----------------|---|
| ● main switch | ⓘ | ● timer | 🕒 |
| ● quick boil timer | A | ● child lock | 🔒 |
| ● cooking zone combination | + | ● options menu | 🔑 |

Operating principle

Main switch

The electronics in the control panel are switched on using the main switch. Touch the  symbol until the cooking zone displays show . Now the cooktop is ready for use.

Touch the  symbol until the cooking zone displays go off. All the cooking zones are switched off. The residual heat indicator remains lit until the cooking zones have cooled sufficiently.

The cooktop cannot be switched on if an object lies on one of the sensor keys. The main switch flashes repeatedly when touched. Remove the object and switch on the cooktop as usual.

The cooktop switches off automatically if all the cooking zones have been switched off for more than 20 seconds.

Touch keys

When you touch a symbol, the respective function is activated. Every input is confirmed by an audible signal.

The settings remain unchanged if several symbols are touched briefly. You can therefore easily mop up spills on the control panel.

Note

Always keep the touch keys clean and dry. Moisture and dirt may impair function.

Cooking zone combination

Flexible cooking zones can be combined in different ways to create larger or smaller cooking surfaces as required.

Quick boil timer

When the quick boil timer is activated, the set cooking level is boosted for several minutes. This ensures that the continued cooking temperature of the food is reached faster.

Twist pad with magnetic twist knob

The twist pad is the area in which you select the cooking zones with the magnetic knob and can set heat settings. The knob automatically centres itself in the twist pad.

The knob is magnetic and is placed on the twist pad. The cooking zone is activated by sliding the twist knob in the direction of the corresponding cooking zone symbol. You can set the heat setting by turning the knob.

You can remove the knob. This makes cleaning easier.

If you remove the knob when the cooktop is in operation, all the cooking zones switch off after 3 seconds.



Caution! If you place a metal object on the twist pad within 3 seconds, the cooktop may continue to heat up. For this reason, always switch off the cooktop using the main switch.

Storing the twist knob

There is a strong magnet in the twist knob. Do not, therefore, place it near magnetic data carriers, e.g. video cassettes, disks, credit cards and cards with magnetic strips. These could be destroyed. Malfunctions to televisions and monitors may occur.



Caution! For persons who wear electronic implants such as a pacemaker or insulin pump.

Implants could be affected by magnetic fields. Do not carry the twist knob in the pockets of your clothing. Keep the twist knob at least 10 cm away from a pacemaker.

Operation

Switching on and off

Touch the ① main switch symbol. A signal is sounded. The cooking zone displays show 0. Now the cooktop is ready for use.

The cooktop switches off automatically if no further inputs are made within approximately 20 seconds.

By touching the ① main switch symbol at any time the cooktop can be quickly switched off.

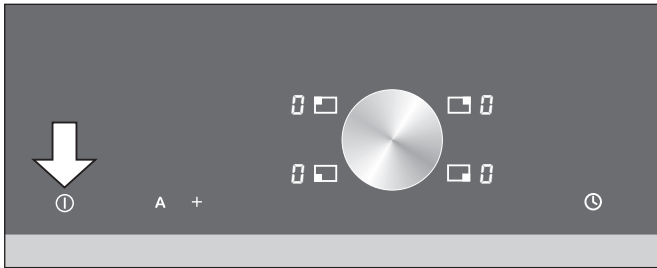

Setting the cooking level

The cooktop must be switched on by the main switch. The switching on and off for all cooking zones is identical. Each cooking zone has 9 heat settings with intermediate settings.

- 1 Select the cooking zone. To do this, slide the twist knob in the direction of the corresponding cooking zone symbol. The cooking zone display shows 0.
- 2 Move the twist knob back to the centre.
- 3 Within the next 5 seconds, turn the twist knob until the cooking zone display shows the desired cooking level. If you select an intermediate setting, a spot appears next to the cooking level. After a few seconds a confirmation signal is sounded.

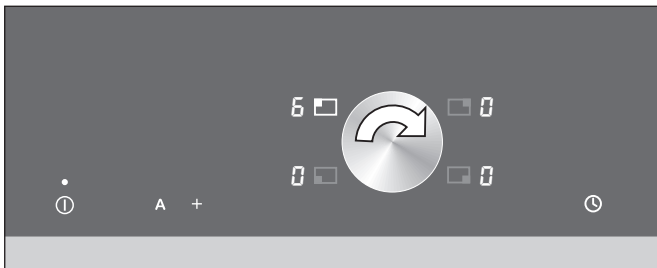
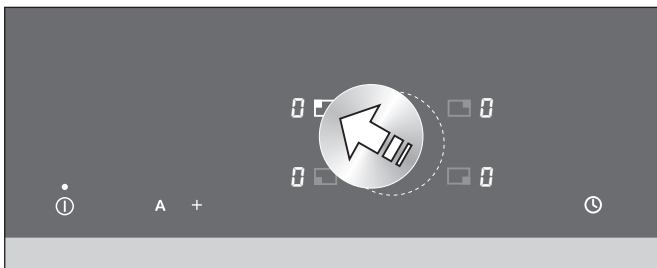

Changing the cooking level

Select the cooking zone. Turn the magnetic knob to the desired cooking level.

Switching off a cooking zone

Select the cooking zone. Turn the magnetic knob to 0. The cooking zone is switched off, and the residual heat display appears after approximately 5 seconds.

Main switch with memory function

The heating and timer settings remain stored for 5 seconds after the cooktop has been switched off.

If you switch the cooktop off accidentally and would like to restore the previous settings:

- 1 Within 5 seconds, touch the ⓘ symbol. The cooking zone display flashes the previous settings.
- 2 Within 5 seconds, select any cooking zone with the twist knob.

The previously stored settings are taken over. If you touch any other symbol instead, the previous settings are lost.

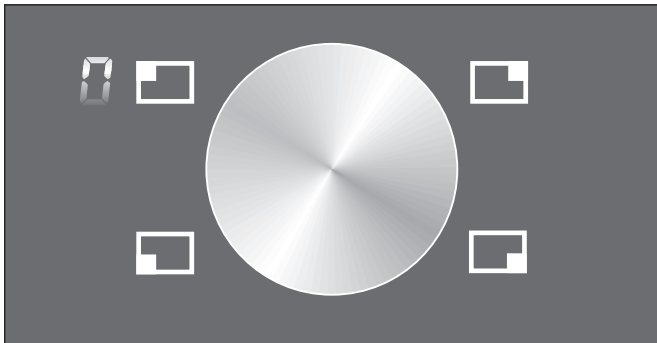

Residual heat display

The residual heat display appears on the display of the relevant cooking zone after switching off. The moving zero in the display indicates that, after switching off, a cooking zone has still not cooled down to such an extent that it can be safely touched.

⚠ Caution, risk of burns! Only touch cooking zones after the residual heat display has gone off.

Safety deactivation

If a cooking zone is in constant use for a long time without the setting being changed, it will automatically switch off. The time after which the holiday safeguard is activated depends on the heat setting (1 to 10 hours).

The cooking zone is switched off, the residual heat display appears on the display until the cooking zone has cooled down.

Now you can switch the cooking zone on again.

Tips on saving energy

Use good quality saucepans and pots with thick, even bases.

Select the correct saucepan size for each cooking zone. The diameter of the bases of the saucepans and pots should match the size of the cooking zone. Note: Ovenware manufacturers often give the diameter of the top of the saucepan. It is usually larger than the diameter of the base of the saucepan.

Use a small saucepan for small quantities. A larger, less full saucepan requires more energy.

Saucepans and pots should always be covered with a suitable lid to shorten cooking times. Cooking without a lid requires much more energy.

Cook with small quantities of water. This saves energy and helps vegetables to retain vitamins and minerals.

Switch down to a lower heat setting in good time.

For longer cooking times you can switch off the cooking zone before the end of the cooking time and then use the residual heat.

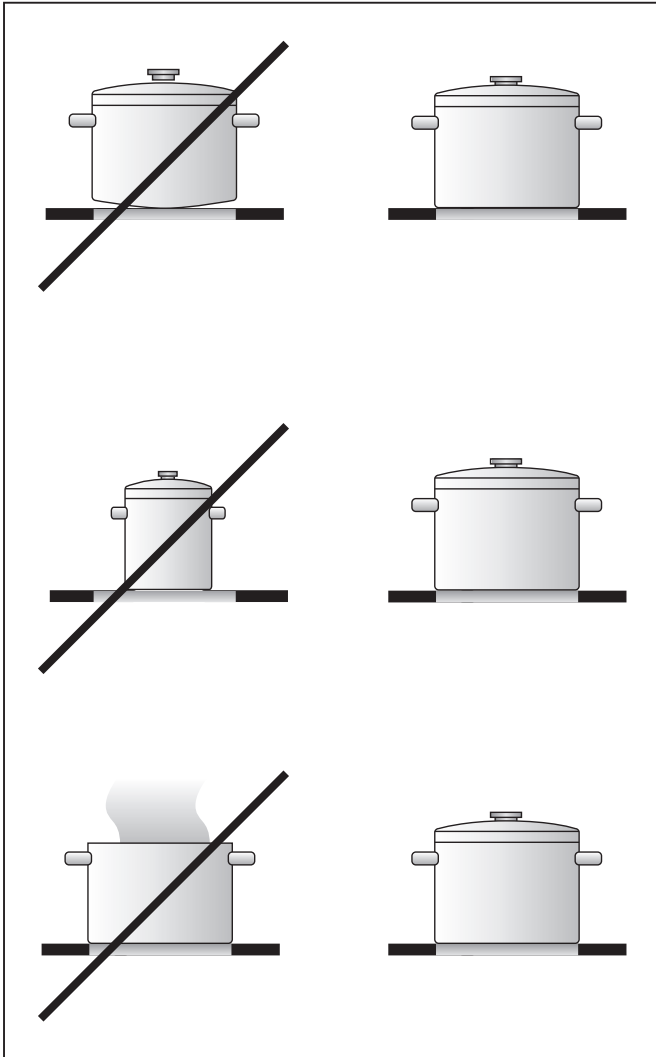

Cooking zone combination

Combination of the dual size cooking zone

The cooktop must be switched on by the main switch.

- 1 Select the cooking zone. To do this, slide the magnetic knob in the direction of the corresponding cooking zone symbol.  comes on in the cooking zone display.
- 2 Move the magnetic knob back to the centre.
- 3 Within 5 seconds, turn the magnetic knob until the desired cooking level is shown on the display.
- 4 Within the next 5 seconds, touch the symbol **+** combination. The combination symbol lights up beside the cooking zone display. After a few seconds a confirmation signal is sounded.

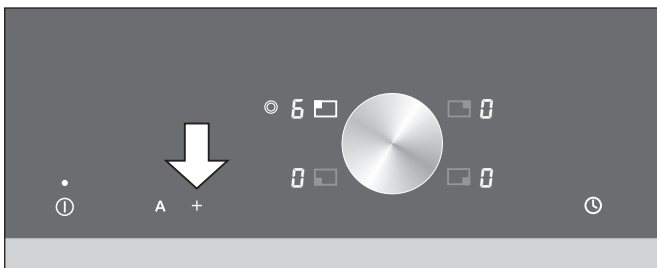

Deactivating combination

Select the cooking zone. Within 5 seconds, touch the symbol **+** combination. The extension symbol goes out.

Note

In the options menu you can choose, if the cooking zone combination should be activated or deactivated when the cooktop is switched on. Alternatively, you can choose to restore the previous setting when the cooktop is switched on.

Settings table

Setting	Cooking method	Examples
9	Boiling Searing Heating Boiling	Water Meat Fat, liquids Soup, sauce
9 - 8.	Blanching	Vegetables
8 - 6 6 - 5	Roasting Roasting	Meat, potatoes Fish
7 - 6	Baking Boiling in open pot	Pancakes, egg dishes Pasta, liquids
6 - 5	Browning Roasting Frying Reducing	Flour, onions Almonds, breadcrumbs Bacon Stocks, sauces
5. - 4.	Simmering in open pot	Dumplings, soup garnish, meat stock, poached eggs
4 - 3	Simmering in open pot	Sausages
5 - 4 3. - 2.	Steaming Stewing Braising Braising	Vegetables, potatoes, fish Vegetables, fruit, fish Rolled beef steaks, roasts, vegetables Goulash
4. - 3.	Boiling with closed lid	Soup, sauces
3. - 2.	Thawing	Frozen foods
3 - 2	Slow cooking Thickening	Rice, pulses Egg dishes
2 - 1	Reheating / keeping warm Melting	Soup, casserole, vegetables in a sauce Butter, chocolate

Each cooking zone has 9 heat settings with intermediate settings. Switch to the highest cooking level in order to reach the required temperature quickly. Then always switch back to the lower cooking level.

The cooking levels are identical for all cooking zones.



The values given above must be looked upon as recommended values. The heat required depends not only on the type and condition of the food, but also the size and contents of the pot.

Timer



With the timer you can program an automatic switch-off time between 1 and 90 minutes in 1-minute-steps for a cooking zone (automatic switch-off). You can set a time value for every cooking zone.

Setting an automatic switch-off time

The cooktop must be switched on by the main switch.

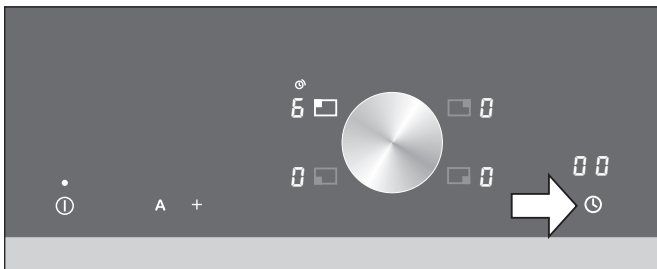
- 1 Select the cooking zone. Within 5 seconds, set the desired cooking level.
- 2 Within the next 5 seconds, touch the symbol .  appears on the timer display.  appears on the cooking zone display.
- 3 Use the twist knob to set the required duration between 1 and 90 minutes.





When the duration has elapsed, the cooking zone switches off.  flashes on the cooking zone display. A signal sounds for three minutes.  flashes on the timer display. Touch any key. The displays will go out and the audible signal will stop.

If you would like to call up the remaining duration for a cooking zone: use the twist knob to select the cooking zone. The duration is displayed for 5 seconds.

If you have set an automatic switch-off time for several cooking zones, the shortest time value will be shown on the timer display. A segment of a circle  appears on the timer symbol of the relevant cooking zone.

Note

If you have set **c5 t.** in the options menu (unlimited selection time for cooking zones), touching the symbol  once will call up the timer. Touch the symbol  again to call up the automatic switch-off time function for the selected cooking zone.

Changing a time value

Select the cooking zone. Touch the ☉ symbol. Use the twist knob to change the duration.

Erasing a time value

Select the cooking zone. Touch the ☉ symbol. Set the duration to 00. The display goes out after a few seconds. The cooking zone continues heating at the selected level.

Note

The timer function is no longer active after a power cut.

Timer

You can use the timer independently from the cooking zones and without switch-off function. The timer can also be used when all cooking zones are switched off.

Setting the timer

The cooktop must be switched on by the main switch. No cooking zone should be selected.

- 1 Touch the ☉ symbol. 00 flashes on the timer display.
- 2 Use the twist knob to set the required duration.

If all cooking zones are switched off, the cooktop will go on stand by mode. Only the timer display stays on.

When the duration has elapsed, 00 flashes on the timer display. A signal sounds for three minutes. Touch the ☉ symbol. The display will go out and the audible signal will stop.

Changing a time value

Touch the ☉ symbol. Change the duration.

Note

The timer is no longer active after a power cut.

Quick boil timer

All cooking zones feature a quick boil timer. When the quick boil timer is activated, the set cooking level is boosted for several minutes. This ensures that the continued cooking temperature of the food is reached faster.

The appliance switches automatically to the set cooking level after the quick boil time has elapsed. You can adjust the duration of the quick boil timer.

The quick boil timer cannot be activated when using cooking level 9.

Switching on the quick boil timer

The cooktop must be switched on by the main switch.

- 1 Select the cooking zone. To do this, slide the twist knob in the direction of the corresponding cooking zone symbol.
- 2 Move the twist knob back to the centre.
- 3 Within 5 seconds, turn the twist knob until the desired cooking level appears on the display.
- 4 Within the next 5 seconds, touch the symbol **A**. The display shows alternatively the chosen cooking level and **A**.
- 5 You can change the quick boil duration within 5 seconds. The preset value is 3 minutes. Turn the twist knob to select a duration between 1 and 20 minutes.

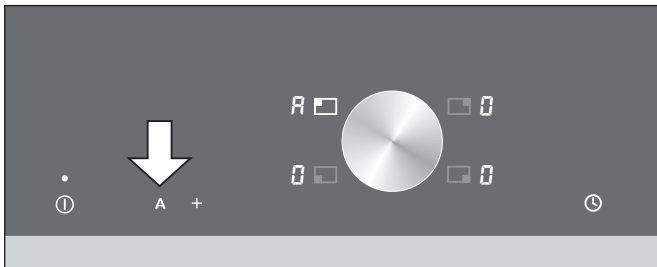

You can set individual quick boil durations for different cooking zones. When you switch on the quick boil timer again, the last setting remains stored.

Switching off the quick boil timer

It is possible to switch off the quick boil timer prematurely (e.g. because the food is boiling over).

- 1 Select the cooking zone.
- 2 Within 5 seconds, touch the symbol **A** quick boil timer. The cooking zone switches back to the set cooking level.





Child lock

You can prevent the cooktop from being switched on unintentionally, i.e. children cannot switch on the cooking zones.

Note

To activate the child lock you have to make the child lock function available in the options menu first (see options menu).

Activating the child lock

- 1 Switch on the cooktop using the main switch. Do not select a cooking zone or the timer. After approximately 10 seconds the symbol  appears above the symbol .
- 2 Touch the  symbol. A signal is sounded. Keep  pressed until a second signal is sounded.

The cooktop is switched off. The symbol  flashes slowly for about 10 seconds. The child lock is activated.

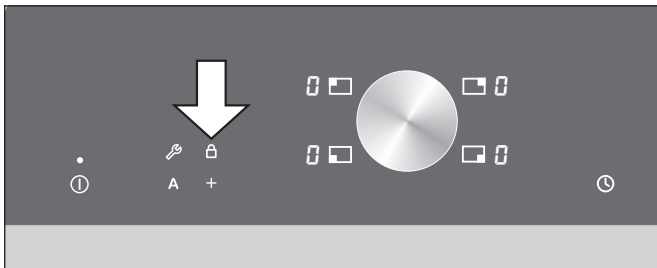

Deactivating the child lock



You can deactivate the child lock again. Proceed in the same manner as for activating the child lock.

Options menu

Using the options menu, you can customize the following functions of your cooktop:

- cooking zone combination
- key tones
- child lock
- reset all parameters
- selection time for cooking zones

Accessing the options menu

- 1 Switch on the cooktop using the main switch. Do not select a cooking zone. The timer must be off. After approximately 10 seconds the symbol  appears above the symbol **A**.
- 2 Touch the **A** symbol and keep it pressed. A signal is sounded. Keep **A** pressed until a second signal is sounded.
- 3 Now you can customize the settings:
 - To move up or down the options menu: touch the **A** symbol until a signal is sounded.
 - To select a setting: touch the **+** symbol or select a setting with the twist knob.
 - To exit the options menu and store the settings: touch the **A** symbol and keep it pressed. A signal is sounded. Keep **A** pressed until a second signal is sounded. (Note: no signal is sounded if  key tones off has been selected.)
 - To exit the options menu without storing the settings: touch the  main switch.

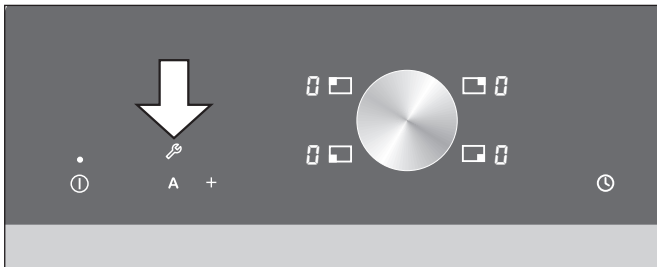

Settings of the options menu

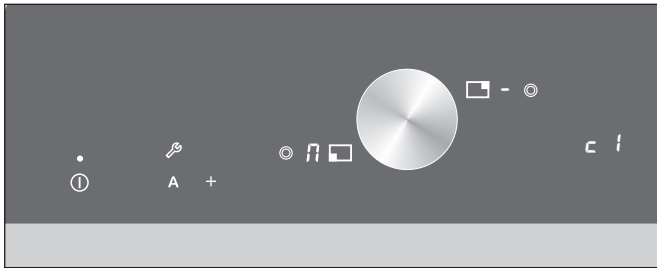

- Cooking zone combination, individually adjustable for each cooking zone with combination feature. First select the desired cooking zone with combination feature. Then touch the **+** symbol to choose the setting:
 - c 1** every time the cooktop is switched on the combination feature has to be activated if desired.
 - c 1 -** every time the cooking range is switched on the combination feature is activated, however, it can be deactivated if desired.
 - c 1 ▯** when the cooking range is switched on the previously used option is activated.

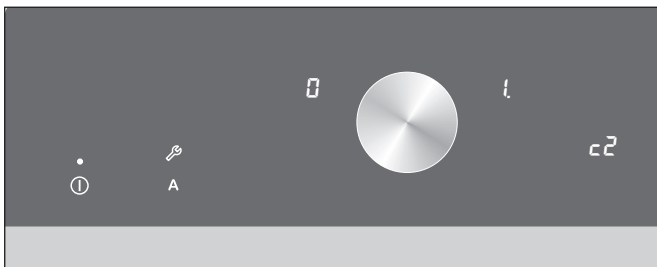

- You can switch the touch key tones on or off. Move the twist knob to the desired setting. A spot appears next to the selected setting.
 - c 2 0.** key tones off
 - c 2 i.** key tones on

Note

The timer signal and warning signal cannot be switched off.

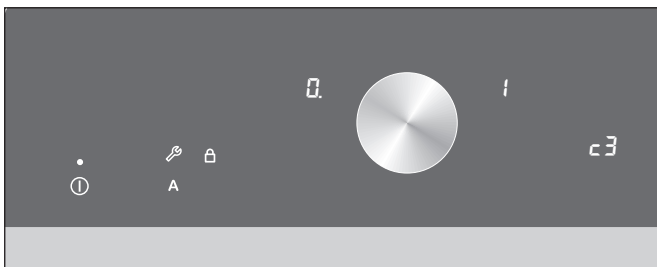

- Child lock available: to activate the child lock you have to make the child lock function available in the options menu first. Move the twist knob to the desired setting. A spot appears next to the selected setting.
 - c 3 0.** child lock not available
 - c 3 i.** child lock available

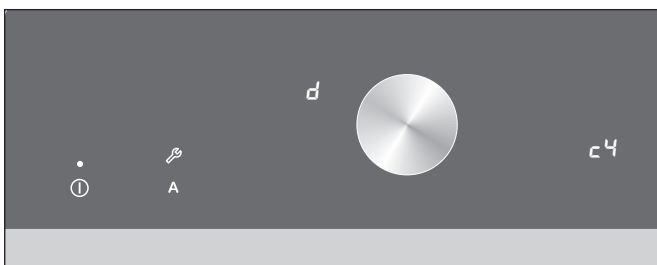

- Reset all parameters in the options menu and the quick boil duration to the factory setting.
 - c 4 d** parameters are different to the factory setting
 Reset all parameters: move the twist knob to **d** . A spot appears next to **d** .

Note

The parameters will only be reset, if you exit the options menu and store the settings. If the display already shows **d** . all parameters are still at the factory setting.

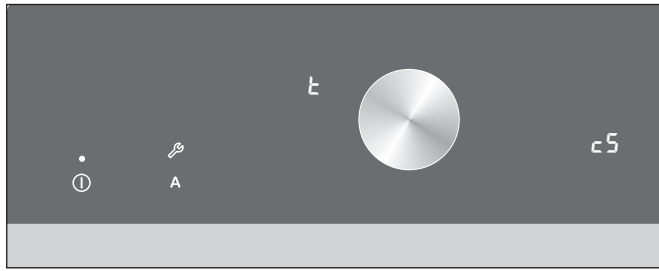



- Selection time for cooking zones 5 seconds or unlimited:
if you select a cooking zone, you have to set the cooking level within the selection time. By setting the selection time to unlimited you can change the cooking level at any time without selecting the cooking zone again.
- c5 ⚡ selection time 5 seconds for cooking zones
 c5 ⚡ unlimited selection time for cooking zones

Note

To exit the options menu and store the settings: touch the **A** symbol and keep it pressed. A signal is sounded. Keep **A** pressed until a second signal is sounded. (Note: no signal is sounded if c2-0 key tones off has been selected.)

If you exit the options menu by touching the ⓘ main switch, the settings will not be stored.

Cleaning and care

-  **Caution!** Do not clean the cooktop using high pressure cleaners or steam jets.
-  **Caution, risk of burns!** Before cleaning, wait until the residual heat display has gone out.
-  **Caution, risk of injury!** The blade of the included glass scraper is very sharp. Replace damaged blades immediately.

Cleaning the glass ceramic

Clean the cooktop after every use. This prevents food from being burnt into the cooktop surface.

Use the blade scraper to remove food residues and grease splashes. Only use the blade on the glass ceramic cooktop. Do not use the blade casing as it may scratch the glass ceramic.

Use a glass ceramic cleaner and kitchen towel or a soft, moist cloth to clean the surface when it has cooled down.

Wipe the surface with a moist cloth and rub dry with a soft cloth.

Do not apply the cleaner if the cooktop is hot. It can become stained. Carefully remove any remaining cleaner before heating up the cooktop.

Water marks can also be removed using lemon juice or vinegar.

The glass ceramic cleaner will coat the glass ceramic surface with a gleaming, dirt repellent film. This will help to preserve the attractive appearance of your cooktop over a long period of time and make it easier to clean as well.

Do not use scouring, abrasive or chemically aggressive cleaners (e.g. oven cleaner). Do not use cleaners which contain sand or chlorine. Do not use undiluted dishwashing or household detergent. Do not use abrasive sponges or brushes.

Food with a high sugar content (e.g. boiled-over milk, jam) can damage the surface of your cooktop. Immediately remove such food using the glass scraper.

Iridescent discoloration can be caused by the use of unsuitable cleaning agents or abrasion from the bases of some pots. These do not interfere with the operation of the glass ceramic cooktop. Remove the discoloration with glass ceramic cleaner.

Always keep the touch keys clean and dry. Food residues and spills can impair the function of the control panels.

Cleaning the stainless steel frame

Use a soft cloth and light soapy liquid or a commercially available stainless steel cleaner to clean the cooktop frame. Only wipe in the direction of the brushed metal.

Do not use any aggressive or abrasive cleaners. Do not use the blade scraper, as it may scratch the cooktop frame.

Do not use lemon or vinegar to clean the cooktop frame. This could result in matt patches.

Cleaning the twist knob

Wipe the magnetic knob using lukewarm soapy water only. Do not use any aggressive or abrasive cleaners. The twist knob could be damaged if cleaned in a dishwasher or immersed in soapy water.

Useful hints

The temperature of the cooking zones is controlled by switching the heat on and off, this means that it is not always possible to see the red, glowing heat. If you select a low heat setting, the heat will switch off more often than at higher heat settings. Even at the highest setting the heat switches on and off.

There may be a gentle buzzing as the cooking zones heat up.

The heat may show differently on the individual cooking zones. Depending on the angle of vision, the heat may appear to spread beyond the marked boundary of the cooking zone. These are technical features and do not influence quality or function.

Maintenance

If the appliance does not function correctly, check the household fuses first. If the power supply is functioning correctly, please contact your dealer or the Gaggenau after-sales service.

Please quote the E number (product number) and the FD number (production number) of your appliance when contacting the after-sales service. The quality control slip bearing these numbers is included with this manual. This quality control slip should be kept, for guarantee reasons, together with your operating and assembly instructions.

Repairs may only be carried out by authorised technicians, in order to guarantee the safety of the appliance.



Caution! Incorrect repairs may result in serious injury to the user.

All poles of the appliance must be disconnected from the mains when being repaired.

Non compliance with these recommendations results in the warranty coverage becoming invalid.

Trouble shooting

Not every malfunction can be ascribed to a defect of your cooker. If your appliance should not function properly, search for the fault in the list below. If you are not successful in remedying the fault with the aid of the list below, then contact your Gaggenau after-sales service.

The cooktop does not work

Check that the household fuses for the appliance are OK. Check if there has been a power cut.

The cooktop cannot be switched on. The main switch flashes repeatedly when touched.

An object lies on one of the sensor keys (e.g. a dish cloth). Remove the object and switch on the cooktop as usual.

The cooktop functions but does not heat up. A spot lights constantly on the timer display.

The cooktop is on show room mode after installation. Disconnect the cooktop from the power supply for at least 10 seconds. Reconnect the cooktop and within 3 minutes carry out the following procedure:

- 1 Switch on cooktop at main switch ①. Timer must be off.
- 2 Touch the symbol **+** and keep the finger pressed down. Within 3 seconds touch and release the main switch ①. The cooktop switches off.
- 3 Remove your finger from the symbol **+**. A signal will sound. The spot on the timer display goes off.

The cooktop has switched itself off

The main switch was touched accidentally. Switch the cooktop back on.

A cooking zone has been in constant operation for too long. The safety deactivation was activated. Switch off the cooking zone. It can be switched on again immediately.

Er display and numbers

If an **Er** and numbers appear on the display, there is a fault with the electronics. Switch the cooktop off and, after a few minutes, on again using the household fuse or the circuit breaker in the fuse box (reset). Disconnect the cooktop from the electricity and call the after-sales service if the display appears again.

Alternating H and 7 display

A cooking zone which is set on level 8 or 9 is too hot. This cooking zone is reduced to level 7. When **H** disappears you can select a higher setting again.

H display

The cooktop is too hot and has switched itself off. Remove the pots from the cooking zones.

H disappears from the display when the cooking zones have cooled sufficiently.

Wait a few minutes until the cooking zones have cooled down slightly. If **H** appears again after the cooking zones are switched back on, the cooktop is still too hot. Switch off the cooking zones and allow to cool further.

F 1 display

A cooking zone has faulty electronics.

Switch the cooktop off and, after a few minutes, on again using the household fuse or the circuit breaker in the fuse box (reset). Disconnect the cooktop from the electricity and call the after-sales service if the display appears again.

F4 display

The control panel is too hot and the cooktop has switched itself off. Check whether there is a hot pan on the control panel.

Remove the pan from the control panel. Wait a few minutes until the control panel has cooled down slightly. If **F4** appears again after the cooking zones are switched back on, call the after-sales service.

Gaggenau Hausgeräte GmbH
Carl-Wery-Straße 34
D-81739 München
www.gaggenau.com

9000347918 TRT 8911 en

GAGGENAU